

COSMETIC CONTAINER MANUFACTURER

Design, Originality, Opportunity
for Cosmetic package

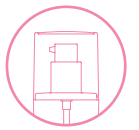

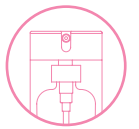
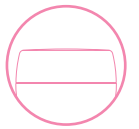

Since its establishment in 1996, DOOCO Co., Ltd. has developed as a company specializing in cosmetic airless bottles, starting with the development of cosmetic pumps. Currently, we are constantly striving to meet the needs of customers in Korea and abroad and repaying them with the best quality.

For over 20 years, we have grown into a professional manufacturer of mold development and plastic molding. Now, with our top priority of customer satisfaction, we are approaching customer satisfaction in the constantly developing market by establishing a production system to provide the quality that customers desire.

Through these efforts, DOOCO Co., Ltd. sympathize with the fact that cosmetic containers are not just tools that contain cosmetic contents. We feel the beauty of cosmetic containers.

Because we value the beauty of customers, we put our best effort into making our products.

Moreover, to improve ourselves to a higher level, we aim to achieve unending growth through innovative thinking and methods and meet our customers.

DOOCO Co., Ltd. will keep on trying to secure competitiveness based on continuous technology development with the top priority of customer satisfaction. We look forward to your continued support and expectations in the future.

Thank you.

CEO **Min Byung-sun**

Design,
Originality,
Opportunity
for Cosmetic
package



HISTORY

1996

- 무역회사 설립 (듀오팩)
- Founded as a trading company (Duo Pack)

1998

- 화장품용 0.2cc & 0.6cc 펌프 개발
- Developed pump for cosmetics (0.2 cc & 0.6 cc)

2006

- 진공 용기 개발
- Developed airless containers

2007

- 진공 용기 ‘트위스트 시리즈’ 개발
- Developed airless containers, “Twist Series”

2014

- 실용신안등록 (아이섀도)
- Acquired Certificate of Utility Model Registration (Eye shadow)

2016

- 해비브로우 용기 생산 공장 설립
- 매출 200억 달성
- Built a new factory for heavy blow molded containers
- Achieved KRW 20 billion in sales

2019

- ISO 14001 환경경영체제 인증 획득
- Acquired ISO 14001 certification (Environmental managementsy stems)

2000

- 회사명 변경 및 법인 설립 (주)두코
- Changed company name and established corporation (DOOCO Co., Ltd.)

2011

- 진공 용기 ‘점보시리즈’ 개발
- Developed airless containers, “JUMBO Series”

2017

- SGS 품질시험 인증획득
- 특허등록 - 화장품용 에어리스 쿠션
- Acquired SGS certification for quality control
- Registered patent - Airless cushion for cosmetics

2020

- 회사 이전 -인천광역시 서구 도담8로 12
- Relocated the company - 12, Dodam 8-ro, Seo-gu, Incheon

2001

- 펌프 자동조립 작업기기 및 검수기 설치
- Installed automatic assembly machine for pump containers and total inspection machine

2013

- 인천시 Main-Biz 선정
- 매출 100억 달성
- Selected as the Main-Biz of Incheon
- Achieved KRW 10 billion in sales

2021

- 에스티로더 그룹사와 거래 시작
- Started business with the Estée Lauder Companies

2003

- ISO 9001 경영 인증 획득
- Acquired ISO 9001 certification (Quality management systems)



CONTENTS

CEO's Message	001	A12	Double Mix	029	
HISTORY	002~003	A13	Injector Airless Series - Refillable	030	
Products		A14	Foundation & Brush Applicator Series	031	
A01	Regular Pump Series - Straight	006	A16	EVO Double Wall Series	032
	Regular Pump Series - Shoulder A, B	007	A17	Standard Regular Pump Series	033
	Regular Pump Series - PPD	008		Standard Regular Pump Series (Refillable)	034
A02	Regular Pump Series - PP	009	A19	Stick Series - Ellipse	035
A03	D03 Regular Pump Series - Double A	010		Stick Series - Circle, Square, Refillable	036
A05	Regular Pump Series - New Twist 2 (Refillable)	011	A20	Aircushion Series - Circle Shape	037
	Regular Pump Series - New Twist 3 (Refillable)	012		Aircushion Series - Square Shape	038
	Regular Pump Series - New Twist 3 (Refillable)	013	A21	Low Profile Series - Essence & Lotion	039
A06	GL Essence Slim Series - Double Wall	014	A22	Square Refill Series - Essence	040
	GL Capless Jumbo Style Series	015	A23	S Fit - Essence & Lotion	041
	GL Skin Care Series - Essence & Lotion	016	C01	GL Skin Care Series - Cream Jar	042
A07	Jumbo Series - Single Wall	017	C02	Standard Cream Series with Ring	043
	Jumbo Series - Double Wall	018	C03	PP Single Wall Bottle	044
	Jumbo Series - N Jumbo, Capless type	019		Cream Jar Series - Double Wall	045
	Mini Jumbo Series - PP, PETG Bottle	020	C04	Skin Care Cream Jar with Standard Cap	046
	Jumbo Series - PETG Bottle	021	C05	Egg Shape Multi Cream Jar	047
	Metal Free Series- PP Bottle	022	C06	Standard Regular Cream Jar Series	048
A08	G-Type Series	023		Standard Regular Cream Jar Series Refillable	049
	G-Type Series - Wide	024	C10	Square Refill Cream Jar - Refillable	050
	C-Type Series	025			
A09	PP Mini Airless Series & Eye Serum Series	026			
A10	Skin Care with Standard Cap&Trumpet Cap	027			
A11	Lip Gloss Series	028			

C16	EVO Double Wall Cream Jar	051	I09	Triton - IBM	075
E01	Blow Bottle A Series - EBM	052	I10	Mars - IBM	076
	Blow Bottle B Series - EBM	053	I12	Square Auto Dropper Series - IBM	077
	Blow Bottle C Series - EBM	054			
	Blow Bottle E / J / T Series - EBM	055	I13	Square Essence - IBM	078
E02	Remover Direct Blow - EBM	056	I14	Mini Vial - IBM	079
E03	Blow Bottle Mint Series - ESM	057	T01	Airless Tube - Φ 19, Φ 25	080
E04	Heavy Blow Series - ESM	058		Airless Tube - Φ 30	081
				Airless Tube - Φ 35	082
E06	Essential Heavy Series - EBM	059			
	JIPA Heavy Blow Series - EBM	060		PUMP & DROPPER	083~088
	JIPA Heavy Blow Cream Jar Series - EBM	061		SKIN CARE FULL SET	089~091
E07	Moon - EBM	062			
I01	Venus - IBM	063			
	Auto Dropper - IBM	064			
	Dropper - IBM	065			
	Venus R & Wide - IBM	066			
I02	Square Venus - IBM	067			
I03	Leo - IBM	068			
I04	Mario - IBM	069			
I05	Aries - IBM	070			
I06	Mercury - IBM	071			
I07	Pluto - IBM	072			
I08	Neptune - IBM	073			
	Uranus Injection Blow - IBM	074			

A01

Regular Pump Series Straight



Specifications

A01-1015 15ml	A01-1020 20ml	A01-1025 25ml	A01-1030 30ml	A01-1035 35ml	A01-1040 40ml	A01-1045 45ml	A01-1050 50ml	A01-6030 30ml
φ26 X 106.5mm	φ26 X 122.5mm	φ26 X 137.5mm	φ31 X 113.7mm	φ31 X 123.7mm	φ31 X 133.7mm	φ33 X 138.4mm	φ33 X 146.2mm	φ31 X 115.2mm

Material · Cap: PETG · Pump button: PP, AL · Pump shoulder: PP, AL · Bottle: SAN, PETG · Base: ABS · Piston: PE

A01

Regular Pump Series

Shoulder A
Shoulder B



Specifications

A01-2015 15ml	A01-2020 20ml	A01-2025 25ml	A01-2030 30ml	A01-2035 35ml	A01-2040 40ml	A01-2045 45ml	A01-2050 50ml	A01-2130 30ml
φ26 X 115mm	φ26 X 130mm	φ26 X 145mm	φ31 X 121mm	φ31 X 131mm	φ31 X 141mm	φ33 X 143.5mm	φ33 X 151.5mm	φ31 X 121mm



Shoulder A



Shoulder B

Material · Cap: PETG · Pump button: PP, AL · Pump shoulder: ABS · Bottle: SAN, PETG · Base: ABS · Piston: PE

A01

Regular Pump Series PPD



Specifications



A01-4015
15ml
φ32 X 87mm



A01-4030
30ml
φ32 X 116mm

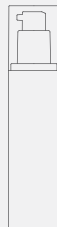

A01-4050
50ml
φ33 X 145mm



Shoulder A



Shoulder B

Material · Cap: PETG · Pump button: PP, AL · Pump shoulder: PP, AL · Bottle: PP · Base: ABS · Piston: PE

A02

Regular Pump Series PP



Specifications

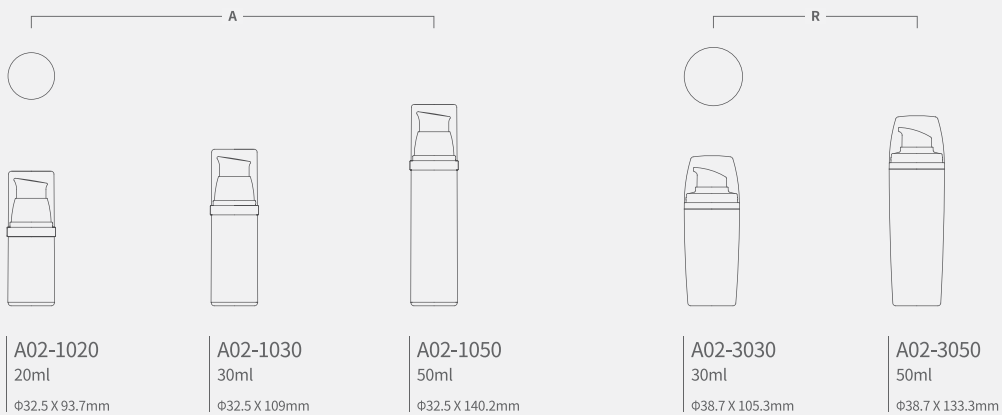

Material · Cap: PP · Pump button: PP · Pump shoulder: PP · Bottle: PP · Base: PP · Piston: PE

A03

Regular Pump Series Double A



Specifications



A03-1040
45ml
Φ37.7 X 151.3mm



A03-1045
45ml
Φ37.7 X 151.3mm



A03-1050
50ml
Φ37.7 X 151.3mm



A03-2040
45ml (Plaque Cap)
Φ37.7 X 151.3mm



A03-2045
45ml (Plaque Cap)
Φ37.7 X 154.1mm



A03-2050
50ml (Plaque Cap)
Φ37.7 X 154.1mm

Material

· Cap: ABS, PETG · Plaque: ABS · Pump button: PP · Pump shoulder: ABS · Outer bottle: SAN · Inner bottle: PP
· Base of inner bottle: PP · Piston: PE

A05

Regular Pump Series **Twist2 (Refillable)**



Specifications



A05-1030
30ml
Φ39.5X 120mm



A05-1050
50ml
Φ39.5 X 155mm

Material

· Pump button: ASA · Outer bottle: ABS · Base of outer bottle: ABS · Inner bottle: PP · Base of inner bottle: PP
· Cap for inner bottle: PP · Piston: PE

A05

Regular Pump Series Twist 3 (Refillable)



Specifications

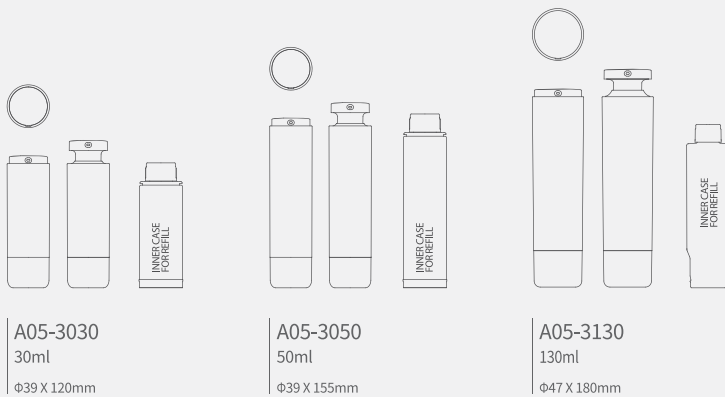

A05-3030
30ml
Φ39 X 120mm

A05-3050
50ml
Φ39 X 155mm

A05-3130
130ml
Φ47 X 180mm

Material

· Button cover: PETG · Inner button: PP · Outer bottle: PETG · Base of outer bottle: ABS · Inner bottle: PP (30ml, 50ml), PETG (130ml)
· Base of inner bottle: PP · Cap for inner bottle: PP · Piston: PE

A05

Metal Free Series
Twist 4 (Refillable)



Specifications

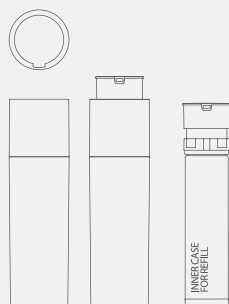

A05-4050
50ml
Φ42 X 145.3mm

Material · Button: PP · Cap: PET · Inner button: PP · Outer bottle: PET · Cap for inner bottle: PP · Base of inner bottle: PP · Piston: PE

A06

GL Essence Slim Series Double Wall



Specifications

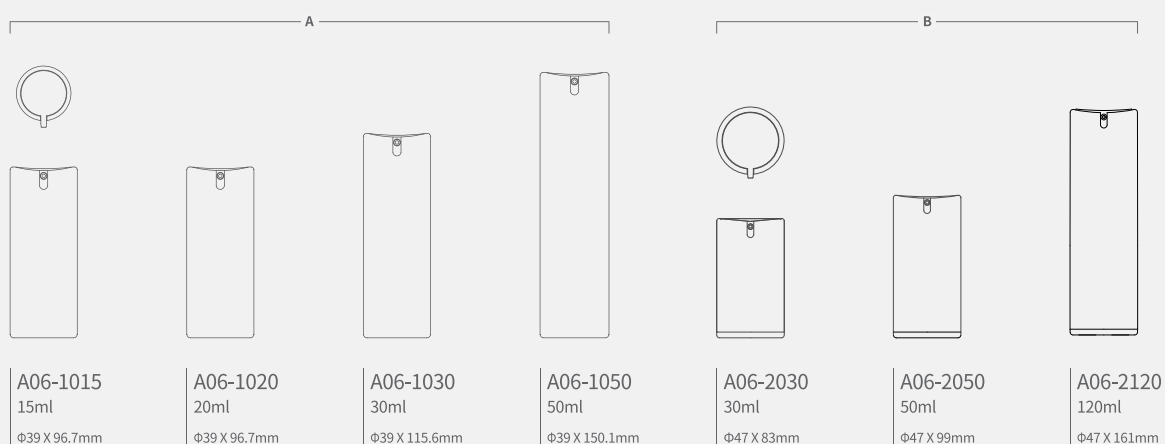

Material A · Cover: PP · Pump button: ASA · Outer bottle: PETG · Inner bottle: PP · Base of inner bottle: PP · Piston: PE

Material B · Cover: PP · Pump button: ASA · Outer bottle: SAN · Inner bottle: PP · Base of inner bottle: PP · Piston: PE

A06

GL Capless Jumbo Style Series



Specifications

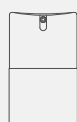

A06-4030
30ml
φ47 X 81mm



A06-4050
50ml
φ47 X 94.5mm



A06-4100
100ml
φ47 X 131.5mm

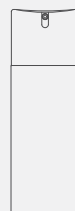

A06-4120
120ml
φ47 X 145mm



A06-4150
150ml
φ47 X 167.5mm

Material · Cover: PP · Pump button: ASA · Pump collar: ABS · Bottle: PP · Base: PP · Piston: PE

A06

GL Skin Care Series Essence & Lotion



Specifications



A06-7050
50ml
φ40 X 152mm



A06-7120
120ml
φ47 X 189mm



A06-8050
50ml (Plaque Cap)
φ40 X 152mm



A06-8120
120ml (Plaque Cap)
φ47 X 189mm

Material

· Cap: PETG · Plaque: SAN · Pump button: PP, AL · Pump collar: PP, AL · Bottle Shoulder: ABS · Outer bottle: SAN
· Inner bottle: PP (50ml), PETG (120ml) · Piston: PE (50ml)

A07

Jumbo Series Single Wall



Specifications



A07-1030
30ml
φ46.7 X 86.5mm

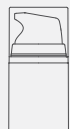

A07-1050
50ml
φ46.7 X 100.1mm

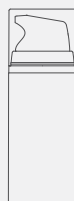

A07-1100
100ml
φ46.7 X 136.2mm

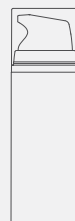

A07-1120
120ml
φ46.7 X 150.6mm



A07-1150
150ml
φ46.7 X 173.1mm

Material · Cover: PP, PETG · Pump button: PP · Pump shoulder: PP · Bottle: PP · Base: PP · Piston: PE

A07

Jumbo Series Double Wall



Specifications

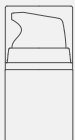

A07-2030
30ml
φ47X 95mm



A07-2050
50ml
φ47 X 111mm

Material · Cap: PP, PETG · Pump button: PP · Pump shoulder: PP · Outer bottle: SAN · Inner bottle: PP · Base of inner bottle: PP · Piston: PE

A07

Jumbo Series N Jumbo, Capless type



Specifications

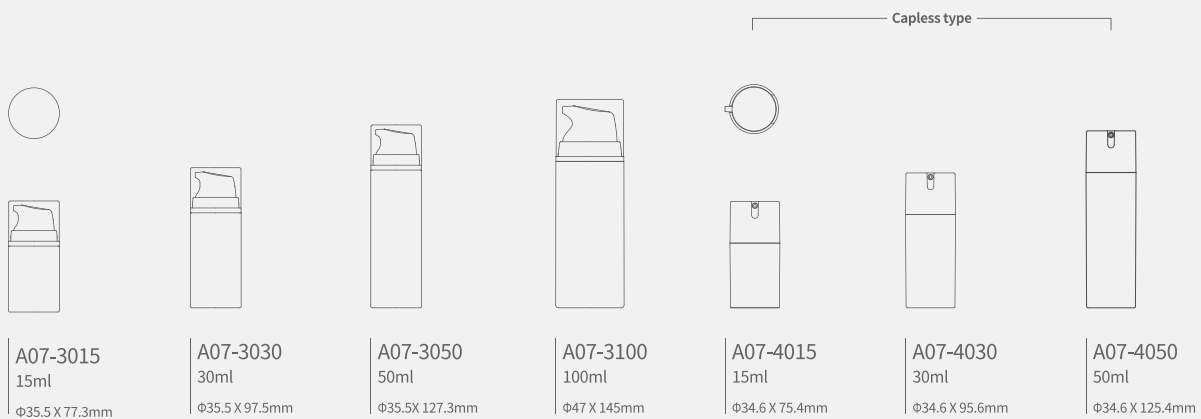

Material · Cap: PP · Pump button: PP · Pump shoulder: PP · Bottle: PP · Piston: PE

A07

Mini Jumbo Series PP, PETG Bottle



Specifications

A			B		
A07-5005 5ml Φ25 X 62.5mm	A07-5010 10ml Φ25 X 76.5mm	A07-5015 15ml Φ25 X 89.5mm	A07-8008 8ml Φ25 X 66mm	A07-8010 10ml Φ25 X 79mm	A07-9010 10ml Φ25 X 79mm

Material A · Cover: PP · Pump button: PP · Pump shoulder: PP · Bottle: PP · Piston: PE

Material B · Cover: PETG · Pump button: PP · Pump shoulder: PP · Bottle: PETG · Piston: PE

A07

Jumbo Series PETG Bottle



Specifications

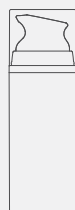

A07-7100
100ml
φ47 X 144mm



A07-7120
120ml
φ47 X 160mm



A07-7150
150ml
φ47 X 181mm

Material · Cap: PETG, PP · Pump button: PP · Pump shoulder: PP · Bottle: PETG · Piston: PE

A07

Metal Free Series PP Bottle



Specifications



A07-0030
30ml
Φ46.6 X 87.6mm



A07-0050
50ml
Φ46.6 X 101.8mm

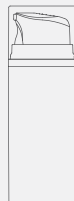

A07-0100
100ml
Φ46.6 X 138.3mm

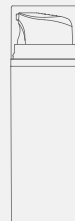

A07-0120
120ml
Φ46.6 X 152.3mm



A07-0150
150ml
Φ46.6 X 173.8mm

Material · Cap: PP · Pump button: PP · Pump shoulder: PP · Bottle: PP · Piston: PE

A08

G-Type Series



Specifications



A08-1030
30ml
φ38 X 106.1mm



A08-1035
35ml
φ38 X 125.2mm



A08-1045
45ml
φ38 X 125.2mm

Material · Cap: PETG · Pump button: PP, AL · Pump shoulder: PP, AL · Bottle: SAN, PETG · Base: ABS · Piston: PE

A08

G-Type Series Wide



Specifications



A08-5030
30ml
Φ47.9 X 100mm



A08-2030
30ml
Φ47.9 X 96.4mm



A08-3030
30ml
Φ47.9 X 99.4mm



A08-3050
50ml
Φ47.9 X 114.4mm

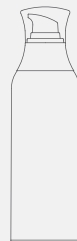

A08-3120
120ml
Φ47.9 X 164.4mm



A08-3150
150ml
Φ47.9 X 185.9mm



Trumpet Shape



Round Shape



Regular Shape

Material · Cap: PETG · Pump button: PP, AL · Pump shoulder: PP, AL · Bottle: SAN · Base: ABS · Piston: PE

A08

C-Type Series



Specifications



A08-9030
30ml
Φ38 X 101mm



A08-9050
50ml
Φ38 X 126mm

Material · Cap: PETG · Pump button: PP, AL · Pump shoulder: PP, AL · Bottle: PETG · Base: ABS · Piston: PE

A09

PP Mini Airless Series & Eye Serum Series



Specifications



A09-2005 (PETG)
5ml
φ19 X 75mm



A09-1005
5ml
φ19 X 75mm



A09-1007
7ml
φ19 X 85mm



A09-1010
10ml
φ19 X 100mm



A09-1015
15ml
φ19 X 126mm



A09-7015
15ml
φ20 X 149mm

Material · Cap: PP · Pump button: PP · Pump shoulder: PP · Bottle: PP · Base: PP · Piston: PE

A10

Skin Care
with Standard & Trumpet Cap



Specifications



A10-2030
30ml
φ43.3 X 115.9mm



A10-2050
50ml
φ43.4 X 150.9mm



A10-2120
120ml
φ50 X 177mm



A10-3030
30ml
φ43.3 X 113.8mm



A10-3120
120ml
φ50 X 173.6mm



Standard Cap



Trumpet Cap

Material · Cap: PETG · Pump button: PP · Pump shoulder: ABS · Outer bottle: SAN · Inner bottle: PP · Base of inner bottle: PP · Piston: PE

A11

Lip Gloss Series



Specifications

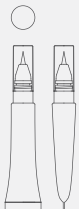

A11-3008
8ml
Φ16X116mm



A11-4008
8ml
Φ16X116mm

Material · Cap: PP · Head: PP · Shoulder: PP · Tube: PE, ABL, PBL, Polyfoil

A12

Double Mix



Specifications

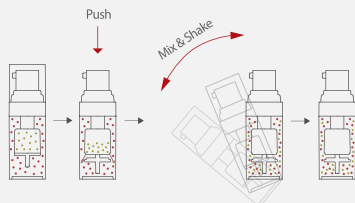

A12-1006
Outer bottle : 8ml
Powder room : 2ml
φ25 X 80mm

Material · Cap: PETG · Pump button: PP, AL · Pump shoulder: PETG · Outer bottle: PETG · Inner bottle: PP

A13

Injector Airless Series Refillable



Specifications

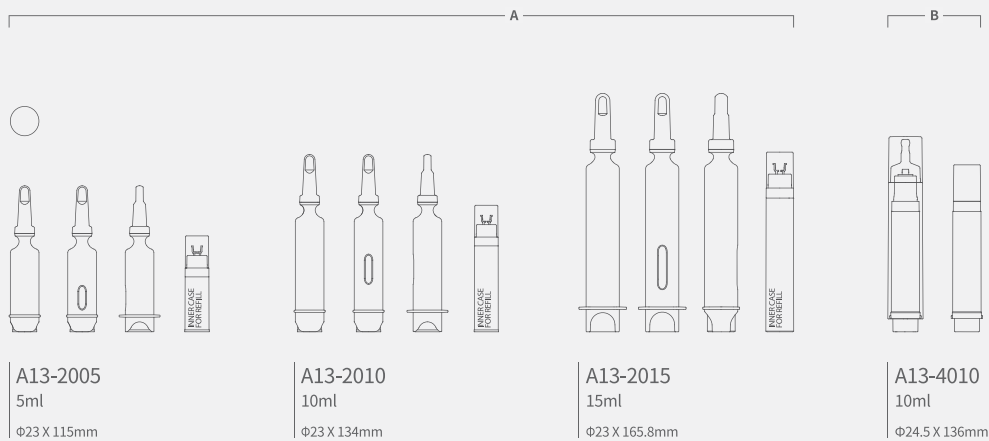

Material A	<ul style="list-style-type: none"> · Cap: PP, PET · Tip: Silicon · Bushing: PP · Outer bottle: PP, PET · Pump shoulder of inner bottle: PP · Cap of inner bottle: PP · Inner bottle: PP · Base of inner bottle: PP · Piston: PE
Material B	<ul style="list-style-type: none"> · Cap: PET · Outer bottle: PET · Pump shoulder of inner bottle: PP · Cap of inner bottle: PP · Inner bottle: PP · Base of inner bottle: PP · Piston: PE

A14

Foundation & Brush Applicator Series



Specifications

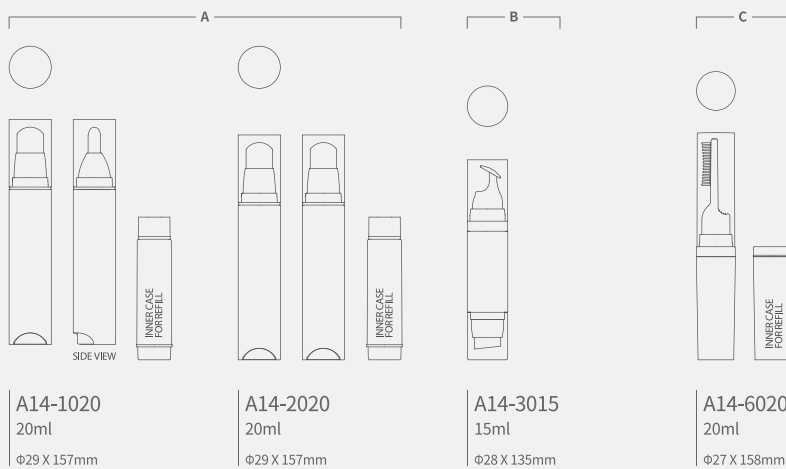

Material A · Cap: PP · Pump button: PP · Pump shoulder: PP · Bottle: PP · Piston: PE · Brush: NYLON

Material B · Cap: PP · Pump button: PP · Pump shoulder: PP · Bottle: SAN · Piston: PE · Brush: NYLON

Material C · Cap: PP · Pump button: PP · Pump shoulder: PP · Bottle: PP · Piston: PE · Brush: NYLON

A16

EVO Double Wall Series



Specifications

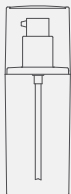

A16-2080
80ml
Φ50.4 X 146.9mm



A16-1140
140ml
Φ50.4 X 187.9mm

Material

· Cap: PETG · Plaque: SAN · Pump button: PP, AL · Pump shoulder: AL · Outer bottle: SAN · Outer bottle shoulder: ABS
· Inner bottle: PETG

A17

Standard Regular Pump Series



Specifications

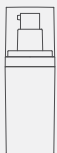

A17-1030
30ml
φ41 X 121.3mm

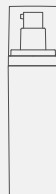

A17-1050
50ml
φ41 X 155.7mm



A17-1120
120ml
φ45.2 X 187.3mm

Material

· Cap: PETG · Pump button: PP, AL · Pump shoulder: PP, AL · Bottle shoulder: ABS · Outer bottle: PETG
· Inner bottle: PP (30ml, 50ml), PETG (120ml) · Piston: PE

A17

Standard Regular Pump Series Refillable



Specifications



A17-3030
30ml
Φ41 X 121.2mm

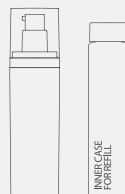

A17-3050
50ml
Φ41 X 155.6mm

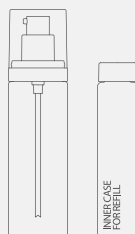

A17-4051
50ml
Φ41 X 158.8mm

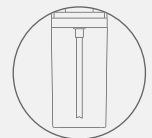

A : Airless type B : Dip tube type

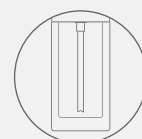

C : Glass Outer Bottle

Material A · Cap: PETG · Pump button: PP, AL · Bottle shoulder: ABS · Outer bottle: SAN · Inner bottle: PP · Base of inner bottle: PP · Piston: PE

Material B · Cap: PETG · Pump button: PP, AL · Bottle shoulder: ABS · Outer bottle: SAN · Inner bottle: PETG

Material C · Cap: PETG · Pump button: PP, AL · Bottle shoulder: ABS · Outer bottle: SAN · Inner bottle: PP

A19

Stick Series
Ellipse

Specifications

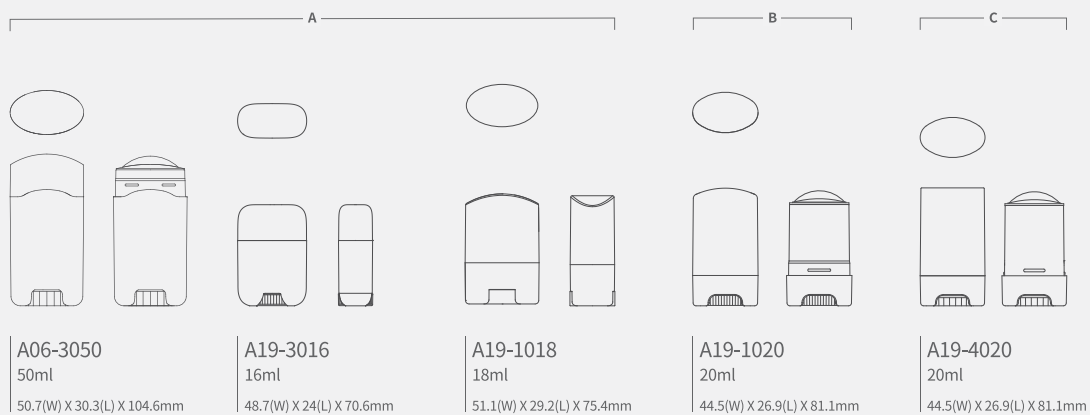

Material A · Cap: PP · Inner cover: PP · Bottle: PP · Dial: PP

Material B · Cap: PP, PETG · Inner cover: PP · Bottle: PP · Dial: PP

Material C · Cap: PETG · Inner cover: PP · Bottle: PP · Dial: PP

A19

Stick Series

Circle, Square, Refillable



Specifications

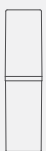

Circle
A19-3010
10ml
Option
(Lower Part, Upper Part, Air Tight)
Φ25.6 X 98.6mm

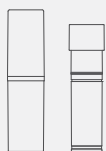

Circle Refill
A19-7010
10ml
Option
(Lower Part, Upper Part, Air Tight)
Φ25.6 X 98.6mm

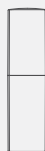

Square
A19-5010
10ml
Option
(Lower Part, Upper Part, Air Tight)
Φ27.2 X 99.3mm

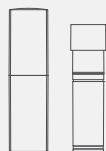

Square Refill
A19-8010
10ml
Option
(Lower Part, Upper Part, Air Tight)
Φ27.2 X 99.3mm



Circle
A19-7020
20ml
Option
(Lower Part, Upper Part, Air Tight)
Φ39.4 X 82.6mm

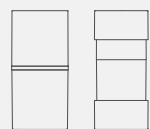

Circle Refill
A19-6020
20ml
Option
(Lower Part, Upper Part, Air Tight)
Φ39.4 X 82.6mm

Material · Cap: PP · Inner cover & Refill cap: PE · Outer Bottle: PP · Inner Bottle: PP · Dial: PP

A20

Aircushion Series Circle Shape



Specifications

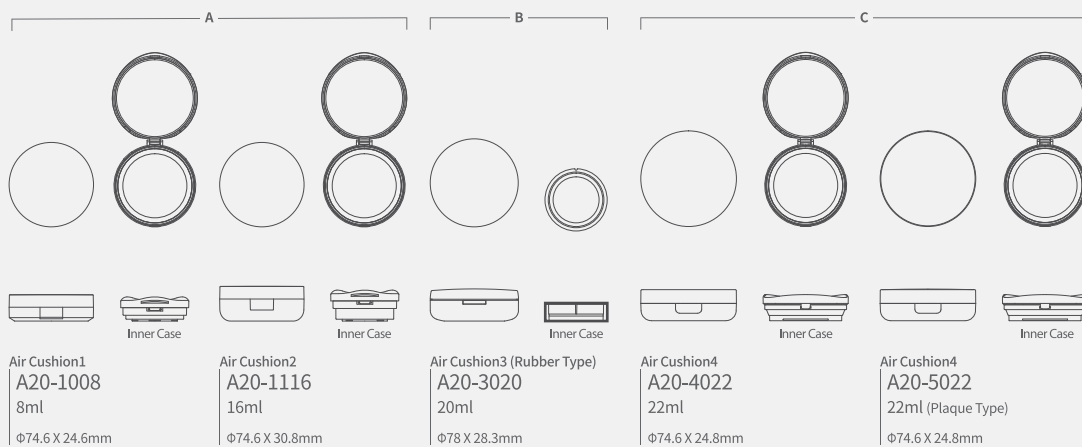

Material A · Upper case: ABS · Lower case: ABS · Middle frame: ABS · Upper Inner bottle: PP · Lower Inner bottle: PE · Push button: PC

Material B · Upper case: ABS · Lower case: ABS · Middle frame: ABS · Inner bottle: PP · Push button: PC

Material C · Upper case: ABS · Lower case: ABS · Middle frame: ABS · Inner bottle: PP · Push button: PC · Upper Inner bottle: PP
· Lower Inner bottle: PE · Plaque: ABS · Ring: PP

A20

Aircushion Series **Square Shape**



Specifications

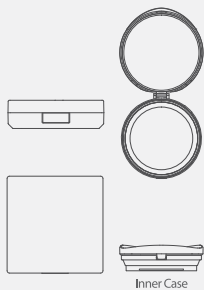

Air Cushion6
A20-6022
16ml
80(W) X 80(L) X 23mm

Material · Upper case: ABS · Lower case: ABS · Middle frame: ABS · Upper Inner bottle: PP · Lower Inner bottle: PE · Push button: PC

A21

Low Profile Series Essence & Lotion



Specifications



A21-1030
30ml
Φ38 X 95.6mm



A21-1050
50ml
Φ38 X 120.7mm



A21-2030
30ml
Φ38 X 95.6mm



A21-2050
50ml
Φ38 X 120.7mm

Material

· Wide Cap: PETG/PET · Narrow Cap: PETG/PET · Pump button: PP · Shoulder: PETG/PET · Bottle: PETG/PET
· Bottle base: PETG/PET · Piston: PE

A22

Square Refill Series Essence



Specifications

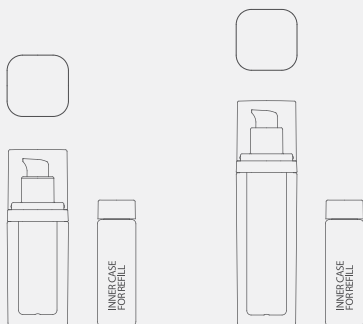

A22-2030
30ml

Φ42.6 X 122.8mm

A22-2050
50ml

Φ42.2 X 156.6mm



A : Airless type



B : Dip tube type

Material

· Cap: PET, PETG · Pump button: PP · Pump shoulder: PET, ABS · Outer bottle: PET, PETG
· Inner bottle: PP(30ml, 50ml), PETG(30ml), PETG/PET(50ml) · Piston: PE · Base of Inner bottle: PP

A23

S Fit Essence & Lotion



Specifications



A23-0030
30ml
Φ31.3 X 117.4mm



A23-0050
50ml
Φ31.3 X 147.4mm

Material · Cap: PP · Pump button: PP · Bottle Shoulder: PP · Bottle: PP · Piston: PE

C01

GL Skin Care Series Cream Jar



Specifications

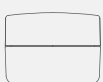

C01-5030
30ml (Wave Cap)
Φ70 X 52mm



C01-5050
50ml (Wave Cap)
Φ70 X 60mm

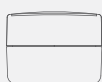

C01-6030
30ml (Plaque Cap)
Φ70 X 52mm



C01-6050
50ml (Plaque Cap)
Φ70 X 60mm



C01-9030
30ml (Standard Cap)
Φ70 X 51mm



C01-9050
50ml (Standard Cap)
Φ70 X 57mm

Material · Outer cap: SAN · Plaque: SAN · Inner cap: ABS · Outer bottle: SAN · Inner bottle: PP · Lid: PP

C02

Standard Cream Series
with Ring



Specifications



C02-1030
30ml
Φ60.5 X 43.5mm



C02-1050
50ml
Φ60.5 X 56.1mm



C02-2030
30ml
Φ60.5 X 43.5mm



C02-2050
50ml
Φ60.5 X 56.1mm

Material · Outer cap: SAN · Inner cap: PP · Outer bottle: SAN · Shoulder of outer bottle: ABS · Inner bottle: PP · Lid: PP

C03

PP Single Wall
Bottle



Specifications

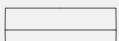

C03-1080
80ml
φ86 X 27mm



C03-1100
100ml
φ86 X 31mm

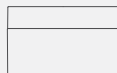

C03-1200
200ml
φ87 X 53mm

Material · Cap: PP · Bottle: PP · Lid: PVC

C03

Cream Jar Series
Double Wall



Specifications



C03-2075
75ml
φ60 X 54.5mm

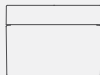

C03-3100
100ml
φ74 X 56mm



C03-3120
120ml
φ74 X 64mm

Material · Cap: PP · Outer bottle: SAN · Inner bottle: PP · Lid: PP

C04

Skin Care Cream Jar
with Standard Cap



Specifications



C04-1030
30ml
Φ70 X 53mm



C04-1050
50ml
Φ70 X 59mm

Material · Outer cap: SAN · Inner cap: ABS · Outer bottle: SAN · Inner bottle: PP · Lid: PP

C05

Egg Shape Multi Cream Jar



Specifications

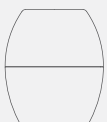

C05-1050
50ml
Φ72 X 83.7mm



C05-2050
50ml
Φ72 X 71.5mm



C05-2100
100ml
Φ72 X 65.9mm



C05-5030
80ml (30ml+50ml)
Φ72 X 83.7mm

Material

· Outer cap: PETG · Middle cap: ABS · Inner cap: PP · Shoulder: ABS · Outer bottle: PETG · Middle bottle: ABS
· Inner bottle: PP · Lid: PP

C06

Standard Regular Cream Jar Series



Specifications

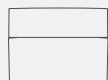
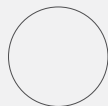

C06-2030
30ml
Φ61 X 47mm

C06-2050
50ml
Φ70 X 52mm

Material · Outer cap: PETG · Inner cap: PP · Outer bottle: SAN · Inner bottle: PP · Lid: PP

C06

Standard Regular Cream Jar
Series
Refillable



Specifications



C06-6030
30ml
Φ61 X 51.8mm

C06-6050
50ml
Φ70 X 54mm

Material · Outer cap: PETG · Inner cap: PP · Outer bottle: SAN · Inner bottle: PP · Lid: PP · Refill cap: PP

C10

Square Refill Cream Jar
Refillable



Specifications



C06-6030
30ml
Φ60 X 48.4mm



C06-6050
50ml
Φ66.3 X 53.5mm

Material · Cap: PET, PETG · Refill cap: PP · Lid: PE · Outer bottle: PET, PETG · Inner bottle: PP

C16

EVO Double Wall Cream Jar



Specifications



C16-3050(75)
50(75)ml
Φ69.9 X 72.4mm

Material · Cap: PETG · Plaque: SAN · Middle bottle: PETG · Outer bottle: PETG · Inner bottle: PP · Lid: PP

E01

Blow Bottle A Series EBM



Specifications

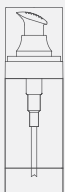

E01-1100
100ml
φ45 X 146mm



E01-1150
150ml
φ45 X 175.7mm

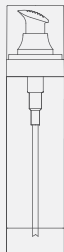

E01-1180
180ml
φ45 X 193mm



E01-1200
200ml
φ45 X 220mm

Material · Cap: SAN, ABS · Pump button: PP · Pump shoulder: ABS, PP · Bottle: PETG · Base: ABS

E01

Blow Bottle B Series EBM



Specifications

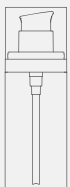

E01-3100
100ml
φ43 X 127.6mm

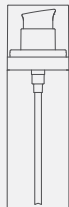

E01-3120
120ml
φ43 X 143mm



E01-3140
140ml
φ43 X 157.7mm

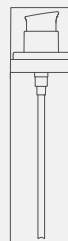

E01-3150
150ml
φ43 X 166mm

Material · Cap: SAN · Pump button: PP · Pump shoulder: ABS · Bottle: PETG

E01

Blow Bottle C Series **EBM**



Specifications



E01-4080
60ml
φ44 X 115mm



E01-4100
80ml
φ44 X 134mm



E01-4150
130ml
φ48 X 156mm

Material · Cap: PETG · Pump button: PP · Pump shoulder: PETG · Bottle: PETG

E01

Blow Bottle E / J / T Series EBM



Specifications

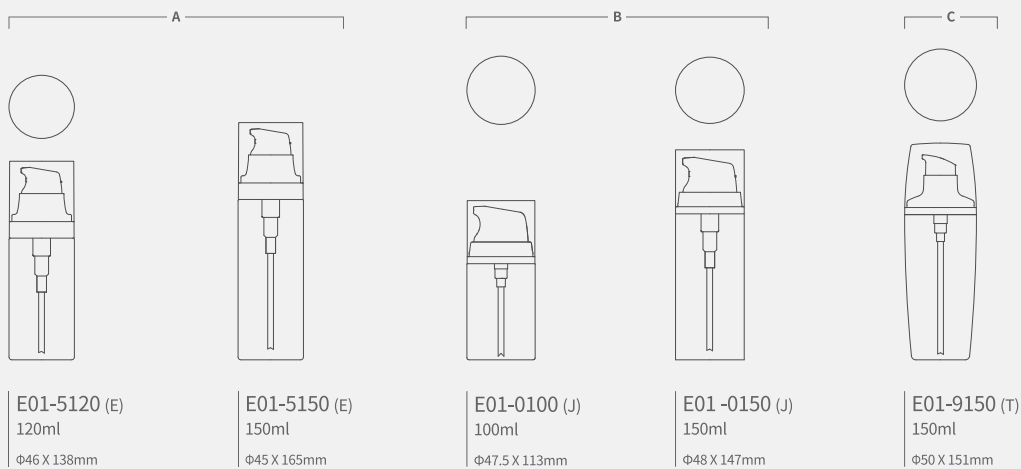

Material A · Cap: SAN · Pump button: PP · Pump shoulder: PP · Bottle: PETG

Material B · Cap: PP · Pump button: PP · Pump shoulder: PP · Bottle: PETG

Material C · Cap: PETG · Pump button: PP · Pump shoulder: ABS · Bottle: PETG

E02

Remover Direct Blow
EBM



Specifications

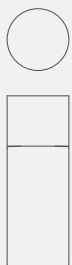

E02-1100
100ml
φ43 X 119mm



E02-1120
120ml
φ43 X 136mm



E02-1140
140ml
φ43 X 147mm



E02-1190
190ml
φ43 X 191mm

Material · Outer cap: PP, ABS · Inner cap: PP · Bottle: PETG

E03

Blow Bottle Mint Series EBM



Specifications



E03-2050
50ml
φ38 X 99mm

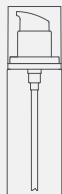

E03-2080
80ml
φ38 X 134mm



E03-2100
100ml
φ38 X 155mm



E03-2120
120ml
φ38 X 175mm

Material · Cap: PETG · Pump button: PP · Pump shoulder: ABS, PP · Bottle: PETG

E04

Heavy Blow Series EBM



Specifications

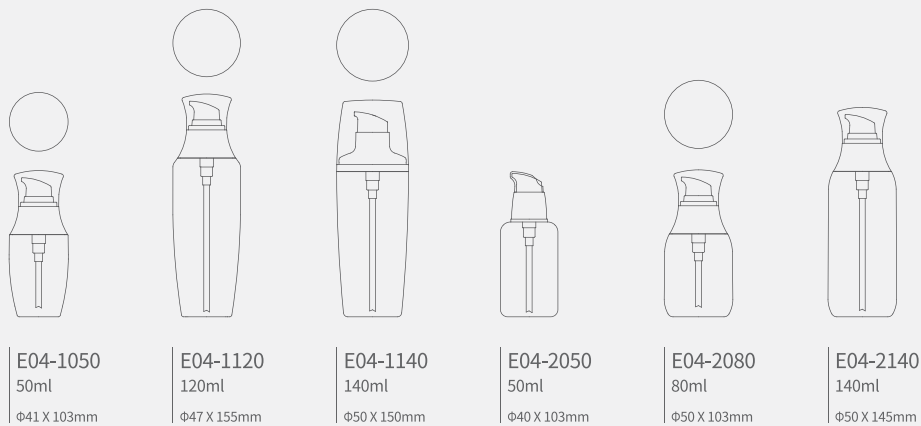

Material · Cap: PETG · Button cover: PP · Pump button: PP · Pump shoulder: ABS · Bottle: PETG

E06

Essential Heavy Series EBM



Specifications



E06-1050
50ml
φ36 X 119mm



E06-1100
100ml
φ40 X 153mm

Material · Cap: PETG · Pump button: PP, AL · Pump shoulder: PP, AL · Bottle: PETG

E06

JIPA Heavy Blow Series
EBM



Specifications



E06-1060
60ml
Φ37 X 135mm



E06-1150
150ml
Φ46 X 191mm

Material · Cap: PETG · Pump button: PP, AL · Pump shoulder: PP, AL · Bottle: PETG

E06

JIPA Heavy Blow Cream Jar Series
EBM



Specifications



E06-1030
30ml
Φ55 X 40mm



E06-1070
70ml
Φ65 X 46mm

Material · Cap: ABS · Bottle: PETG · Lid: PP

E07

Moon
EBM



Specifications



E07-1050
50ml
Φ32 X 121mm



E07-1090
90ml
Φ39 X 137mm



E07-1101
100ml
Φ34 X 127mm

Material · Cap: PP, PETG · Pump button: PP, AL · Pump shoulder: PP, AL · Bottle: PETG

101

Venus
IBM



Specifications

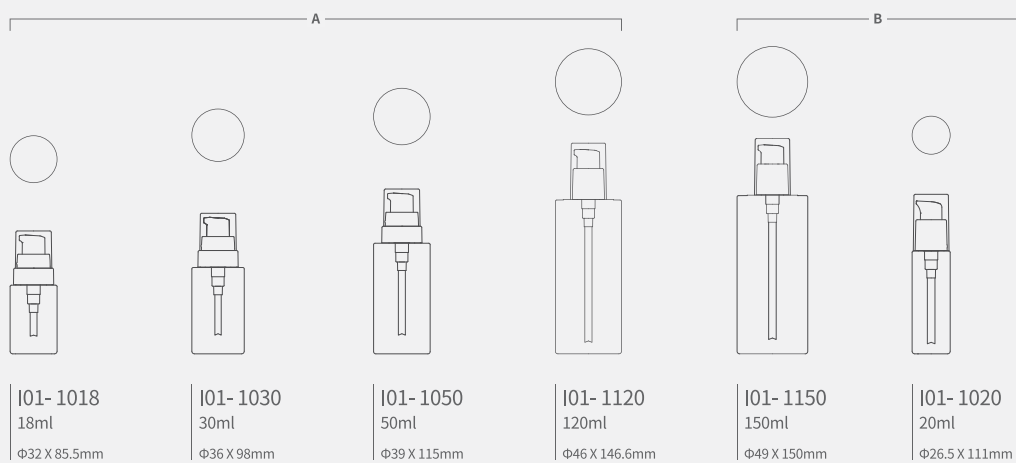

Material A · Cap: PP · Pump button: PP · Pump shoulder: PP · Bottle: PET

Material B · Cap: PETG · Pump button: PP · Pump shoulder: PP · Bottle: PET

101

Auto Dropper IBM



Specifications

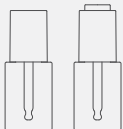

I01-4018
18ml
φ32 X 83.7mm

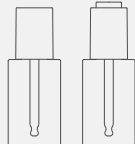

I01-4030
30ml
φ36 X 95.9mm

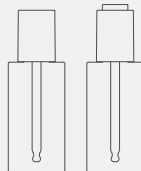

I01-4050
50ml
φ39 X 113.4mm



I01-7020
20ml
φ26.5 X 111.5mm

Material · Button: ABS · Shoulder: ABS · Pipet: Glass · Wiper: PE · Bottle: PET

I01

Dropper IBM



Specifications

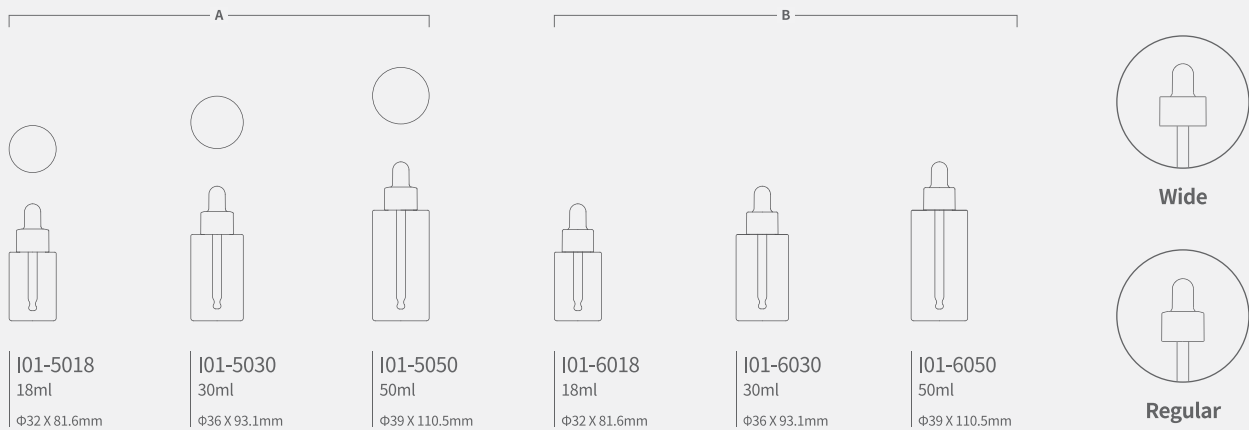

Material A · Button: TPE, NBR · Outer cap: PP · Pipet: Glass · Wiper: PE · Bottle: PET





Material B · Button: TPE, NBR · Outer cap: PP, AL · Pipet: Glass · Wiper: PE · Bottle: PET

101

Venus R & Wide IBM

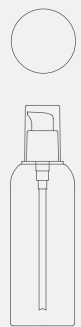

Specifications

				
I01-2030 30ml Φ36.5 X 101.8mm	I01-2050 50ml Φ39.4 X 120mm	I01-2120 120ml Φ45 X 153.4mm	I01-3030 30ml Φ41 X 90.5mm	I01-3050 50ml Φ42.5 X 102.7mm

Material · Cap: PETG · Pump button: PP, AL · Pump shoulder: PP, AL · Bottle: PET

102

Square Venus IBM



Specifications

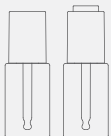

I02- 1030
30ml
Φ31 X 87.8mm



I02- 1050
50ml
Φ34 X 102mm

Material · Button: ABS · Shoulder: ABS · Pipet: Glass · Wiper: PE · Bottle: PET

103

Leo
IBM



Specifications

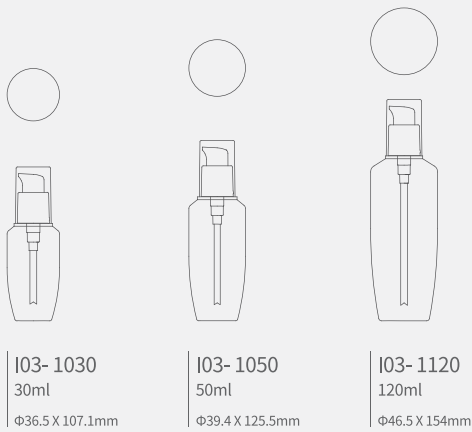

Material · Cap: PETG · Pump button: PP, AL · Pump shoulder: PP, AL · Bottle: PET

104

Mario
IBM



Specifications

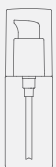

I01-1030
30ml
Φ33 X 111.5mm



I01-1050
50ml
Φ33 X 144mm

Material · Cap: PP · Pump button: PP, AL · Pump shoulder: PP, AL · Bottle: PET

105

Aries
IBM



Specifications

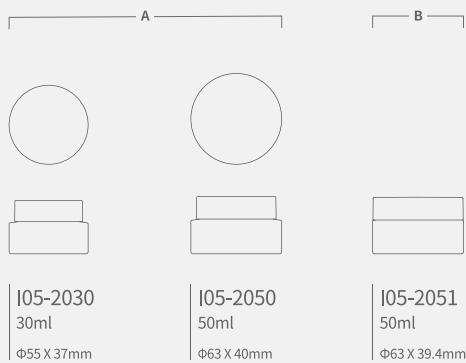

Material A · Cap: ABS · Bottle: PET · Lid: PP

Material B · Cap: PET · Bottle: PET · Lid: PE

106

Mercury
IBM



Specifications



106-1050
50ml
Φ38 X 108mm



106-1100
100ml
Φ38 X 163mm



106-1120
120ml
Φ45 X 143mm

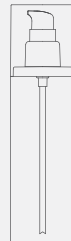

106-1150
150ml
Φ45 X 166mm

Material · Cap: PETG · Pump button: PP, AL · Pump shoulder: PP, AL · Bottle: PET

107

Pluto
IBM



Specifications

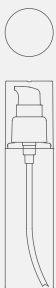

107-2070
70ml
Φ34 X 145mm



107-2150
150ml
Φ52 X 139.5mm

Material · Cap: PP · Pump button: PP, AL · Pump shoulder: PP, AL · Bottle: PET

108

Neptune
IBM



Specifications

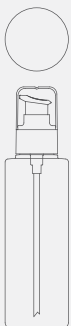

I08-0150
150ml
φ44 X 168mm



I08-1200
200ml
φ52 X 165mm



I08-1300
300ml
φ55 X 195mm

Material · Cap: PP · Pump button: PP · Pump shoulder: PP · Bottle: PET

108

Uranus Injection Blow IBM



Specifications

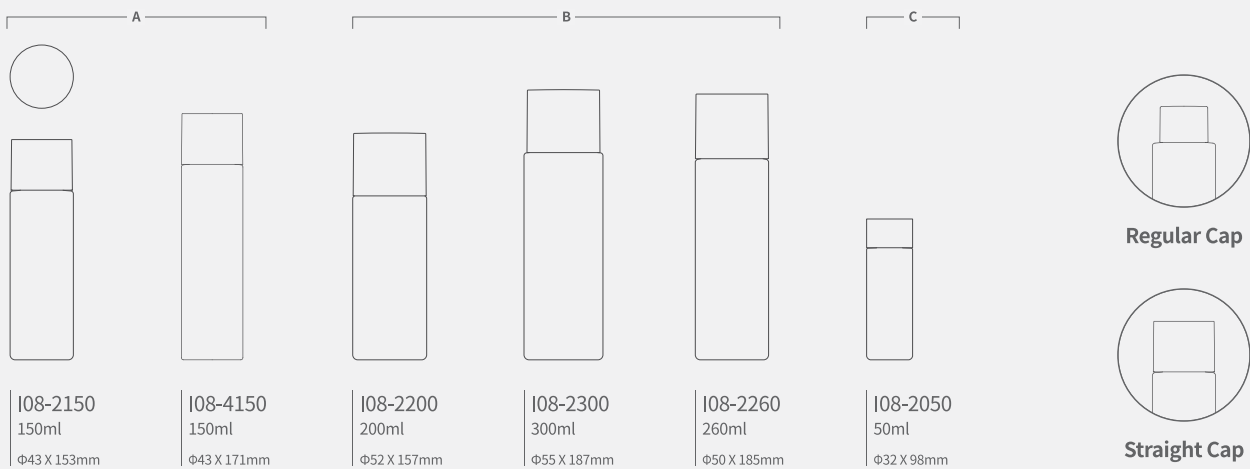

Material A · Outer cap: PP, ABS · Inner cpp: PP · Bottle: PET

Material B · Out cap: ABS · Inner cpp: PP · Bottle: PET

Material C · Out cap: PP · Inner cpp: PP · Bottle: PET

109

Triton
IBM



Specifications

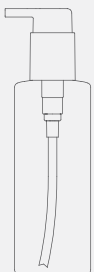

109-1200
200ml
Φ50 X 160mm



Regular Cap



On & Off Pump

Material · Pump button: PP · Pump shoulder: PP · Bottle: PET

I170

Mars
IBM



Specifications

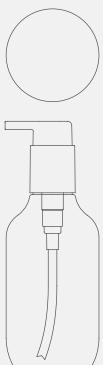

I10-1300 (ver.1)
300ml
Φ64.6 X 171.11mm



I10-1500 (ver.1)
500ml
Φ74 X 196.5mm



I10-2300 (ver.2)
300ml
Φ59.4 X 175.9mm

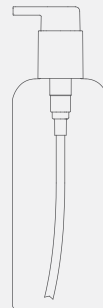

I10-2500 (ver.2)
500ml
Φ67 X 210.8mm

Material · Pump button: PP · Pump shoulder: PP · Bottle: PET

I12

Square Auto Dropper Series IBM



Specifications

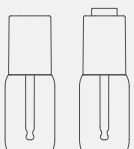

I12-1030
30ml
Φ34.5 X 93.9mm

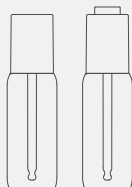

I12-1050
50ml
Φ34.5 X 121.3mm

Material · Button: ABS · Shoulder: ABS · Pipet: Glass · Wiper: PE · Bottle: PET

I13

Square Essence
IBM



Specifications



I13-0150
150ml
Φ42X172.6mm

Material · Cap: PET, PETG · Pump button: PP, PETG · Pump shoulder: PET · Bottle: PET

I14

Mini Vial
IBM



Specifications



I14-0010
10ml
Φ24.7 X 72.3mm



I14-1010
10ml
Φ24.7 X 69.5mm



I08-2010
10ml
Φ24.7 X 52.6mm

Material

· Over Cap: PP, PET · Pump button: PP · Pump shoulder: PP · Dropper Cap: PP · Bulb: NBR · Pipet: Glass · Wiper: PE · Nomal Cap: PP
· Bottle: PET

T01

Airless Tube
Φ19, Φ25



Specifications

T01-0119 0.18cc Φ19 X 135.3mm	T01-0019 0.18cc Φ19 X 134.8mm	T01-0025 0.25cc Φ25 X 146.1mm	T01-0125 0.25cc Φ25 X 140mm	T01-0225 0.25cc Φ25 X 140.2mm

Material · Cap: PETG, ABS, PP · Pump button: PP · Pump shoulder: PP, ABS · Tube: PE, ABL

T01

Airless Tube
Φ30



Specifications



T01-0030
0.25cc
Φ30 X 157.1mm



T01-0130
0.25cc
Φ30 X 153.1mm



T01-0230
0.25cc
Φ30 X 154.6mm



T01-0330
0.25cc
Φ30 X 151.5mm

Material · Cap: PETG, ABS, PP · Pump button: PP, AL · Pump shoulder: PP, ABS · Tube: PE, ABL

T01

Airless Tube Φ35



Specifications



T01-0035
0.25cc
Φ35 X 171.3mm



T01-0135
0.25cc
Φ35 X 166.6mm



T01-0235
0.25cc
Φ35 X 166.1mm



T01-0335
0.25cc
Φ35 X 171.4mm

Material · Cap: PETG, ABS, PP · Pump button: PP · Pump shoulder: PP, ABS · Tube: PE, ABL

P01



Cap



P02



P02

Metal



Essence Pump A
4001 $\Phi 18$



Essence Pump B
4002 $\Phi 18$



Essence Pump D
4004 $\Phi 18$



Essence Pump E
4005 $\Phi 18$



Essence Pump I
4007 $\Phi 18$



Essence Pump J
4008 $\Phi 18$



Essence Pump L
4010 $\Phi 18$



Essence Pump M
4011 $\Phi 18$



Essence Pump A
7001 $\Phi 18$



Essence Pump B
7002 $\Phi 18$



Essence Pump E
7005 $\Phi 18$



Essence Pump I
7007 $\Phi 18$



Essence Pump J
7008 $\Phi 18$



Essence Pump L
7010 $\Phi 18$



Essence Pump M
7011 $\Phi 18$

P03



Essence Pump A
1001 $\Phi 20$



Essence Pump B
1002 $\Phi 20$



Essence Pump E
1005 $\Phi 20$



Essence Pump F
1006 $\Phi 20$

Pump



Essence Pump I
1007 $\Phi 20$



Essence Pump J
1008 $\Phi 20$



Essence Pump A
6001 $\Phi 20$



Essence Pump B
6002 $\Phi 20$



Essence Pump E
6005 $\Phi 20$



Essence Pump F
6006 $\Phi 20$



Essence Pump I
6007 $\Phi 20$



Essence Pump J
6008 $\Phi 20$



Essence Pump L
6009 $\Phi 20$



Essence Pump M
6011 $\Phi 20$



Essence Pump Q
6010 $\Phi 20$

P03

Metal



Essence Pump A
5001 $\Phi 20$



Essence Pump B
5002 $\Phi 20$



Essence Pump D
5004 $\Phi 20$



Essence Pump E
5005 $\Phi 20$



Essence Pump F
5006 Φ 20



Essence Pump I
5007 Φ 20



Essence Pump J
5008 Φ 20

P04



Essence Pump A
1001 Φ 24



Essence Pump B
1002 Φ 24



Essence Pump E
1005 Φ 24



Essence Pump F
1006 Φ 24



Essence Pump I
1007 Φ 24



Essence Pump J
1008 Φ 24



Essence Pump R
1018 Φ 24

P05



Essence Pump G
1801 Φ 18



Essence Pump G
1802 Φ 18



Essence Pump G
1803 Φ 18



Essence Pump G
2201 Φ 22



Essence Pump G
2203 Φ 22



Essence Pump G
3301 Φ 33



Essence Pump G
4020 Φ 20



Essence Pump K
4018 Φ 18

P06



Bulky Pump
9001 $\Phi 18$

P07



Heavy Blow Pump
1502 $\Phi 18$



Trumpet Blow Pump
1602 $\Phi 18$



Essence Pump
1701 $\Phi 18$



Essence Pump
1702 $\Phi 18$



Blow Pump A-A
2006 $\Phi 24$



Blow Pump B
3002 $\Phi 18$



Blow Pump A-C
4006 $\Phi 24$



Blow Pump E
5006 $\Phi 24$



0.6cc Pump O
7006 $\Phi 24$



0.6cc Pump H
8006 $\Phi 24$



Oil Pump II
9106 $\Phi 24$

P10



Essence Pump LP SP
2001 $\Phi 18$



Essence Pump LP
2100 $\Phi 18$

P11



Auto Dropper
1001 $\Phi 18$

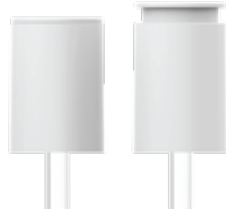

Auto Dropper (Plaque)
1002 $\Phi 18$



Dropper
5001



Dropper (Metal)
6001



Wide Dropper
6001

P12



Mini Pump
1001 $\Phi 16$

P13



ON&OFF Pump
0000 $\Phi 20$

X02



Olive Young Pump
8001 $\Phi 18$

GL Skin Care Full Set



Skin Care Full Set with Standard Cap



Skin Care Full Set with Trumpet Cap



EVO Double Wall Skin Care Full Set



Standard Regular Skin Care Full Set



Standard Regular Skin Care Full Set Refillable





인천 서구 도담 8로 12 **TEL.** 032-543-9966 **FAX.** 032-543-9967 **EMAIL.** doocotra@naver.com
www.dooco.co.kr

Information in this catalogue can be changed without notice.